



Vistosi



Vetreria Vistosi Srl · Via G. Galilei, 9-9/A-11 · 31021 Mogliano V.to · Treviso · Italy
P. Iva IT02497840278 · Cap. Soc. € 100.000,00 I.V. · N° R.E.A. TV - 170728
Cod. Fisc. - R.I. N° 01808840266 · Iscr. Reg. AEE N° IT08010000000170
Tel. +39 041 5900170 - 041 5903480 · Fax +39 041 5900992 - 041 5904540
vetreriavistosi@legalmail.it · www.vistosi.it · vistosi@vistosi.it



AZIENDA CERTIFICATA UNI EN ISO 9001:2000

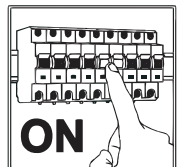
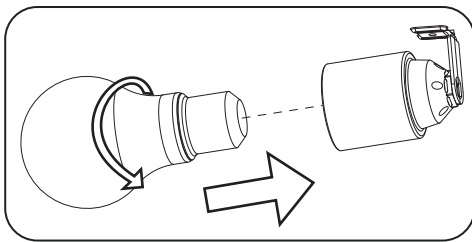
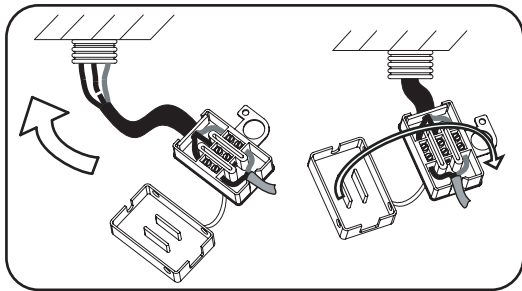
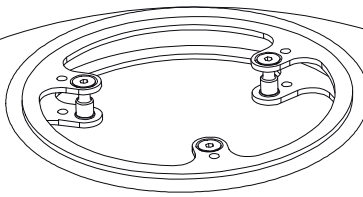
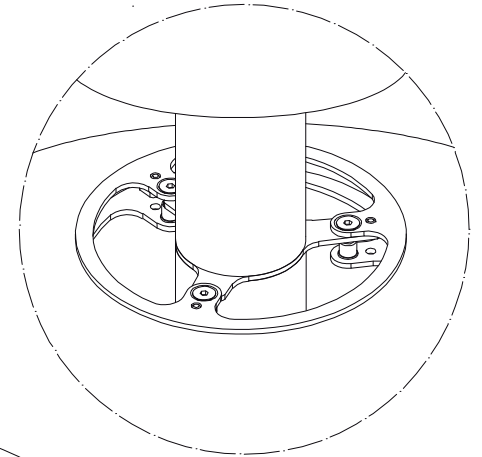
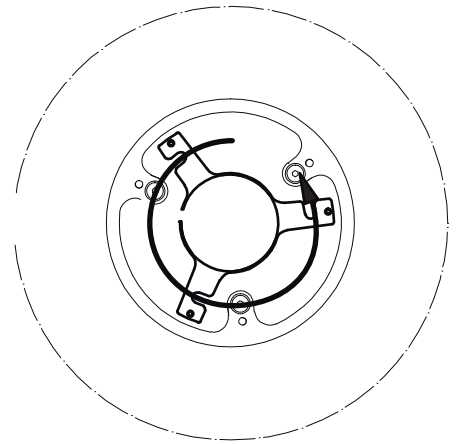
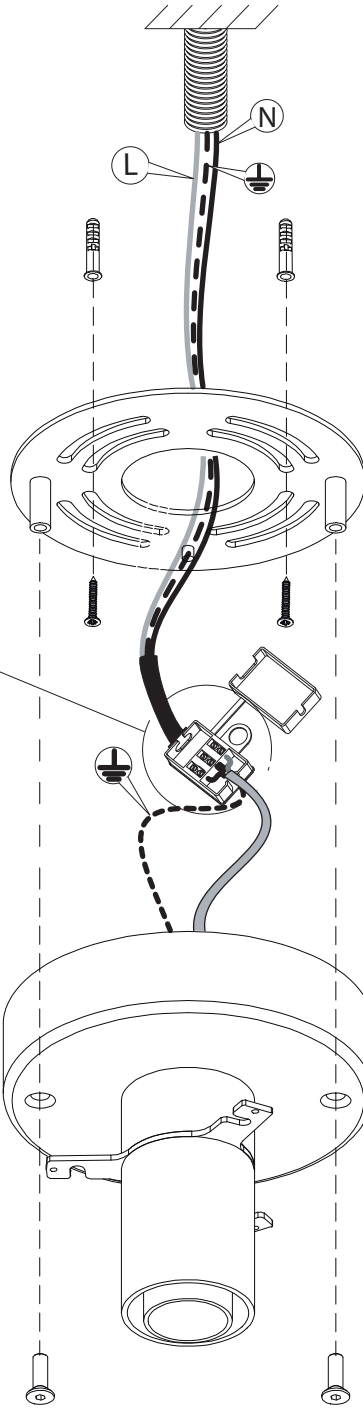
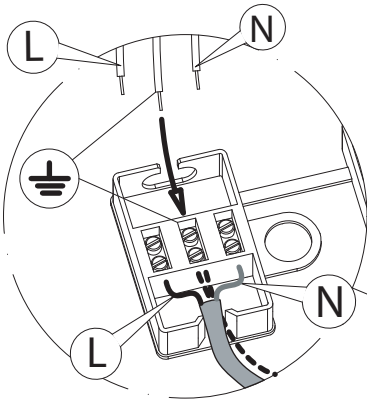
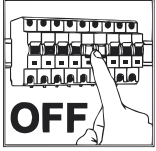

BOLLE PL G CE

(Rev 00)

Led Version

Vistosi

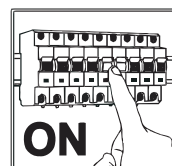
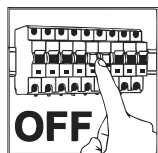



DC MAXI JOLLY HC BI - 122415

Wiring diagram - Schema di collegamento

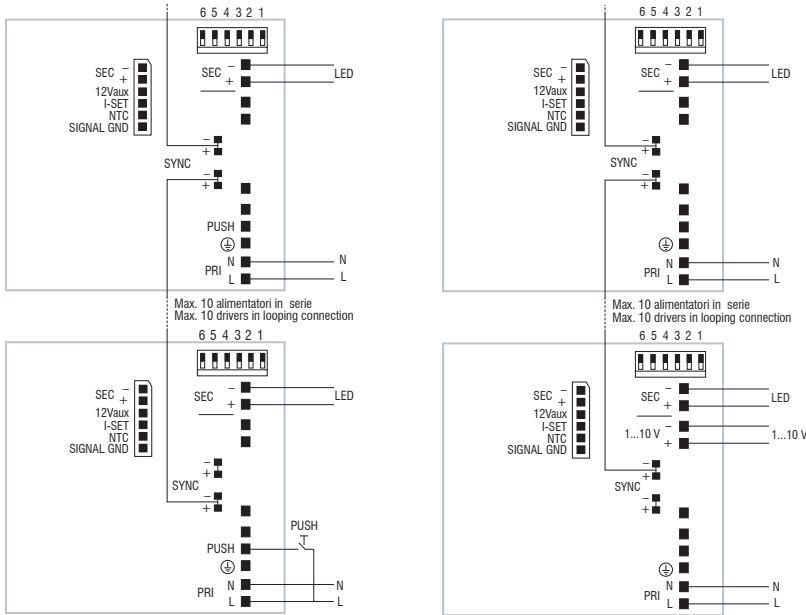

PUSH diagram - Collegamento PUSH

1...10 V diagram - Collegamento 1...10 V

Attenzione: le seguenti istruzioni si riferiscono a più articoli. Se il driver presente nell'imballo non corrisponde a quello indicato nell'istruzione, fare riferimento a questa pagina del manuale.

Warning: The following instructions refer to several articles. If the driver included in the packaging does not match indicated in instruction, refer to this manual page.

DC MICRO JOLLY 6W 500mA - 122428

Wiring diagram - Schema di collegamento

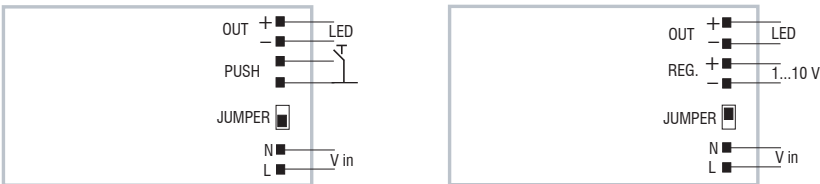

PUSH diagram - Collegamento PUSH

1...10 V diagram - Collegamento 1...10 V

DC MINI JOLLY BI - 122404

Wiring diagram - Schema di collegamento

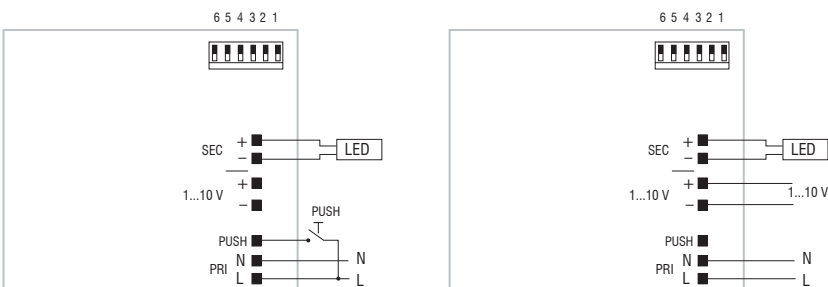

PUSH diagram - Collegamento PUSH

1...10 V diagram - Collegamento 1...10 V